

Varenummer: 2310431069S  
Beskrivelse: E+G Stilleben  
LX.30-SW17-M10X23-S

## Mål

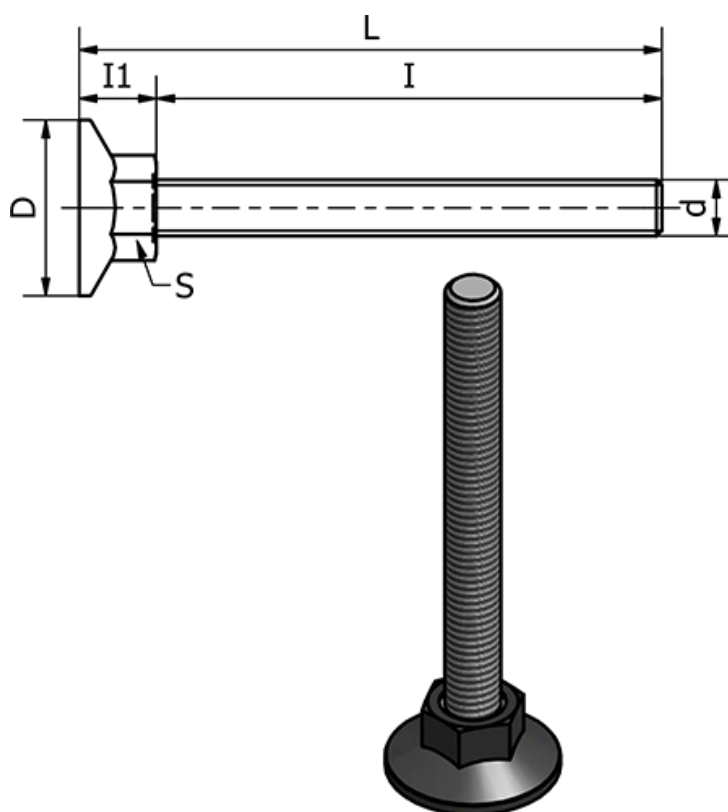

d	= M10
D	= 30
I	= 23
I1	= 12
L	= 35
Max statisk belastning (N)	= 3000
S	= 17
Type	= Forzinket

Vægt (g) = -